

**LANGFEITE**

***H1***

# User Manual

Model: Langfeite H1



LANGFEITE **H1**



## General Information Disclaimer & Warning

This manual was written to provide you (the “buyer” or “rider” or “user” or “customer” or “you” or “your”) all the information required for proper use and maintenance of your Electric Scooters and all the risks involved in the use of the Electric Scooter (E-Scooter)

Please read this instruction manual before taking your E-Scooter (the “E- Scooter” or “electric scooter” or “vehicle” or “product”) out for its first ride. It is important to understand the functions and features before operating it for the first ride. You must be aware of the risks involved in riding the electric scooter. Your Electric Scooter will require some adjustments and a break-in period for all moving parts to adjust themselves into the correct position.

Each country and region has a different set of rules and regulations pertaining to the usage of e-scooters, (including where e- scooters can legally be used and whether they need to be registered with the relevant road traffic authority). Any user of this product must check and follow their local by laws, as well as use responsibly. Ride with caution and always wear a helmet and protective gear when riding your E-scooter.

The Electric Scooter manufacturer’s published performance data is based on factory testing under controlled conditions and should be used for comparison purposes only. Your Electric Scooter performance will depend on the circumstances in which you operate the E-scooter and the environment of usage; therefore, the “company” (or “we” or “us”) will not be held responsible for the warranty, repair, or replacement of products that don’t meet the manufacturer’s published performance specifications. You undertake to be solely responsible and to indemnify the importer, wholesaler, retailer and all of its employees, managers, directors, Retailers/ Importers/ Wholesalers and representatives against all liabilities for claims, demands, actions, suits, losses, costs, charges, expenses, damages, penalties, injuries, death, personal injury (whether fatal or otherwise), lawyers’ fees, judgments, or disbursements of any kind, or nature whatsoever, whether foreseeable or unforeseeable, including, but not limited to, the negligence of the released parties, caused due to your use of the electric scooter.

You acknowledge that accidents, personal injury, death, and other harm can happen when you are operating an e-scooter, including as a result of falling, collisions, encountering hidden obstacles and varying terrain, and aggravation of existing health conditions, and you shall be solely responsible and not make us liable for such unforeseen events.

You will bear all loss or damage to the vehicle and any other losses, damage, costs, and expenses whatsoever and howsoever caused during your ride, without claiming from Retailers/Importers/Wholesalers.

The completion of a financial transaction to purchase an Electric Scooter product acknowledges and accepts the content of this disclaimer statement. This Disclaimer does not deprive you of your legal and/or consumer guarantee rights.

## Disclaimer:

1. The customer understands there is a risk of serious injury or death in the operation of such products and shall agree to take the necessary precautions and exercise good judgment to avoid hazards and dangerous situations that may result in serious injury or death.
  - a. The use of safety and protective gear is strongly encouraged.
  - b. The use of a helmet is mandatory by the law.
2. The customer is advised to take the following precautions:
  - a. Do not ride on wet ground or in heavy rain.
  - b. Take corners slowly and look out for pedestrians.
  - c. Avoid potholes, curbs, and debris on the ground.
  - d. Keep tyres pumped to the specified pressure as per manufacturer guidelines.
  - e. Dismount in places with heavy human traffic and push the E-Scooter manually.
  - f. You must have your E-Scooter serviced as per the service schedule in this manual or risk voiding your warranty. Failing to service your E-Scooter as per Service Schedule may render your E-Scooter unsafe; not road worthy and dangerous to use which will put you at risk of serious injury or death.
  - g. Do not use the product on public roads, and respect local road regulations.

# SAFETY NOTES, WARNINGS, PRECAUTIONS

IMPORTANT ADVICE BEFORE YOU START RIDING YOUR E-SCOOTER:

PRIOR TO RIDING: Please ensure that the folding mechanism is locked, and the safety lock is fully engaged.

- Most countries and regions have local laws governing the use of electric scooters. You should check your local laws before riding your electric scooter, to understand where you can and where you cannot ride it, what speed you are allowed to ride it, and what safety precautions you have to observe whilst riding it.
- Riders must be the age of 18 or over to ride this electric scooter.
- You acknowledge and accept that you must wear a helmet that meets the standard certification ("Permitted Helmet") as varied by federal regulation at all times, whether required by law or not.
- Riders must keep their E-Scooter well maintained and giving it a thorough check before each ride is essential to ensure a safe and hassle-free ride. Please check if all screws, nuts, and bolts on the E-Scooters are tight.
- Riders must check whether the handlebar is tight and firm, brake levers, throttle, and display are correctly adjusted at the optimal viewing angle.
- Check that the stem folding clamp is correctly locked into position and properly tightened.
- People with no previous experience of riding an E-Scooter should first seek professional training on riding the E-Scooter and choose a safe, open place to practice riding the E-Scooter before riding it in busy areas where there may be pedestrians and/or traffic.
- Certain regions require safety devices and/or gears. It is your responsibility to know the state laws and follow them.
- Do not ride on wet ground or in rain.
- Take corners slowly and look out for pedestrians.
- Avoid potholes, curbs, and debris on the ground.
- Understand and strictly comply with local traffic regulations.
- Keep tyres pumped to the specified manufacturer's recommendation of tyre pressure.
- Dismount in places with heavy human traffic and push the E-Scooter manually.
- Wearing knee and elbow pads while riding your electric scooter is also recommended, as this may help prevent bone fractures if you fall off the E-scooter

- Please make sure that your body is in good condition before riding. Do not ride under the influence of alcohol or take sedatives or any other form of medication before seeking medical advice.
- Never operate a mobile phone while using your E-Scooter.
- Please do not do anything that may harm other people or their properties when riding your E-Scooter.
- Never modify or use aftermarket parts or components. Any modification of the electric scooter can potentially make it dangerous and will void any warranty. This E-Scooter is built to perform in a specific manner, and any changes to its factory settings may make it dangerous to ride. Please do not submerge in the electric scooter or ride it in the rain. Water damage to the control panel, display unit, or battery will void the warranty and may also make it dangerous to ride.
- Always perform mechanical checks on the E-Scooter's brakes and other parts that allow visibility, safety, and functionality.
- Check the tyres and wheels, make sure there is no sign of wear and tear, and nothing is in need of replacement. Always ensure that the brake mechanism is not in contact with the wheels and that free spinning is permitted.
- Never overload the E-Scooter beyond its maximum load capacity.
- Never ride your E-scooter after a collision, crash, or drop.
- Never ride your E-scooter near salt water, or on the beach, or through water (Water damage or saltwater damage is not covered by warranty.)
- Do not use the E-Scooter in areas where entry is prohibited by law in the country, region, state, or city.
- Never use/ride your E-Scooter with one hand or free hand. Both hands must be on the handlebars at all times.
- Avoid riding in risky areas or terrains not allowed under product specification and product usage guideline.
- Do not do jumps, stunts, kerb climbing, or motocross on your E-Scooter.
- Do not use the E-Scooter in areas where entry is prohibited by law in the country, region, state, or city.
- Minors under the age of 18 are not permitted to use this product unsupervised.
- Never carry another person or tow anything behind your E-Scooter.
- Never ride an E-Scooter if you are pregnant, visually impaired, or have any disability. You must seek medical advice first.
- Do not use your Mobile phone when riding your E-Scooter.
- Do not ride your E-Scooter under rain, snow, road ice, water, wet dirt road and other hazardous conditions.
- Do not ride your E-Scooter during low visibility.

# WARNING

IMPROPER USE OF THIS ELECTRIC SCOOTER MAY LEAD TO SERIOUS INJURY OR DEATH.

There is an inherent risk in riding an E-Scooter. For your safety, please learn to ride safely and obey the local rules. Only ride the electric scooter in a controlled manner and in an environment where it is permitted for use.

Before each ride, check that the tyres are in good condition, the brake works and that parts such as the clamp and bar handles are securely tightened.

## BATTERY CHARGING AND MAINTENANCE

1. Before using the E-Scooter for the first time, please charge the battery to the full charge.
2. Avoid depleting your E-Scooter's battery to fully empty, before charging, always make sure there is a minimum of 10% charge remaining.
3. For satisfactory vehicle performance, the battery has to be charged at a minimum of 50% capacity.
4. When storing your E-Scooter for long periods (over 01 month), make sure the battery is at least 40-50% charged. It is advisable to re-charge (boost charge) your E-Scooter a minimum of once per 30 days to maintain the 40-50% level of charge.
5. Never store your E-Scooter fully charged or empty.
6. Failure to correctly maintain or charge your E-Scooter battery during long periods of storage will damage and shorten its life span and void your warranty.

## CAUTION

1. Only use approved and original chargers.
2. Never charge your E-Scooter if it's wet or the charging port shows any signs of damage or debris inside.
3. Never charge your E-Scooter immediately after riding it. You must not charge your E-Scooter for at least 1 hour. Charging straight after a ride may cause premature damage or risk battery fires or explosions.
4. Do not leave your E-Scooter unattended while it is charging.

# Battery Safety and Charging

- Don't modify or repair batteries.
- Only use the original charger that was supplied with your E-Scooter to charge the lithium-ion battery. The use of a third-party charger could cause serious damage to the battery and may cause a fire or explosion.
- Don't try to use the battery or charger with other electrical equipment it was not designed for.
- Never use a charger that has a different output charging voltage from the input charging voltage of the scooter or battery-operated equipment – this could cause a fire.
- If you use a charger with the wrong voltage output or have the wrong batteries in the scooter or battery-operated equipment, you could cause a fire or explosion.
- Before charging, check both the E-Scooter and charging device for any signs of damage including:
  - cracked or broken parts of the case of the charger, or E-Scooter battery enclosure
  - discoloration of the charger case or battery enclosure that may show overheating has occurred.
  - water ingress
  - bulging of battery pack or enclosure
  - damaged charger cords (cuts, exposed internal wires, severe kinks, discoloration, melting and pulled out of plugs or connectors parts).
- Charge during the day when you are home and alert to any signs of electrical failure.
- Charge away from the effects of the weather, and where you can monitor the device to check if anything abnormal is occurring (e.g. smoke, popping noises, flames).
- Immediately switch off the charger when the batteries are fully charged.
- Install and regularly test a working smoke alarm where charging occurs.
- Keep the scooter or battery-operated equipment and charger in an area clear from clutter so any heat generated during charging can safely dissipate and keep away from any flammable products like loose papers, clothes, bedding, couches, or curtains.
- To prevent overcharging, unplug the charger once the charger light indicates the battery is fully charged. Do not charge the E-Scooter overnight. Instead, resume charging when you are available to unplug the charger once the battery is fully charged.
- Do not leave the lithium-ion battery exposed to direct sunlight or high temperatures. Do not store it in wet places. Always store it in a dry place.
- Charge lithium-ion batteries in dry, open, and well-ventilated places away from living areas or inside your home. Do not charge the battery near flammable goods.
- In the winter, keep the E-Scooter stored inside, away from extreme temperatures. Do not let the battery run flat. At all times, the E-Scooter must have at least a 20% charge.

- If the battery protection circuit is damaged, the battery may emit an unusual smell. Contact your authorized service center immediately for technical support.
- Do not reverse the polarity on a battery and short-circuit. Exposing the battery to excessive shock can result in an explosion of the battery.
- Do not try stunts or jumps on the E-Scooter. Exposing a battery pack to excessive shock can result in a battery fire. If in an accident, contact your service center to ensure that the battery is not compromised.
- Connecting the charger when the product is waterlogged will run the risk of an electric shock and possible fire. Do not charge the battery and contact your service center.
- Do not disassemble or incinerate the lithium-ion battery.
- If the battery requires replacement after long-term use, always replace it with one that was purchased from an authorized dealer.
- Do not use the battery if it leaks or gives off an odor. Do not attempt to charge it.
- Depending on the model, riding conditions, and rider's weight, the range will vary on a full charge. Please note that batteries operate optimally at around 25 degrees Celsius. In colder weather, it is normal for your E-Scooter to experience a shorter than normal range on a full charge.
- When the E-Scooter needs to be stored for a long period of time, make sure the E-Scooter is charged at 50%. Never fully charge your battery or leave it near empty for long periods of storage (more than 1 month). This will damage the battery.
- If there is smoke or ignition of your battery or E-Scooter, immediately stop charging or using your E-scooter; move the product outdoors and use an approved fire extinguisher to diffuse it. Do not spray or immerse the product in water to diffuse the fire.

# Warnings and Precautions

- It is forbidden to directly weld the battery pack or pierce the battery pack with nails or other sharp tools.
- Do not mix old and new batteries.
- Don't disassemble batteries.
- It is prohibited to use and leave the battery beside a hot and high-temperature source (such as a fire, heater, etc.)
- It is prohibited to immerse the battery in seawater or water. When not in use, it should be placed in a cool and dry environment.
- Do not throw the battery pack into the fire or heater.
- It is prohibited to transport or store battery packs with metals such as hairpins or necklaces.
- It is forbidden to directly connect the positive and negative electrodes of the battery with metal for a short circuit.
- It is forbidden to knock, throw, or step on the battery pack.
- Do not use or place the battery under high temperatures (direct sunlight or in hot vehicles); otherwise, it may cause overheating, function failure, and a short service life of the battery.
- Do not put batteries in an environment above 60°C for a long time.
- If the battery leaks and electrolyte get into your eyes, do not rub them. Wash the eyes with clean water immediately and take them to a doctor for treatment; else, the eyes will be damaged.
- The discarded battery shall be wrapped with insulating paper to prevent the positive and negative contact short circuit of the battery.
- Do not operate the E-Scooter while charging.
- Charge the battery only using our approved and original charger.
- Correctly align the plug with the groove in the charging port.
- Connect with the plug in a correct way when charging.
- Do not touch the charging port with any metal objects – this may cause a short circuit or explosion.
- To prevent water damage, please do not use the E-Scooter on rainy days.
- Keep the charging port dry and always cover the charging port with the cover supplied.
- Always check the charging port before charging the E-Scooters. Never charge your E-Scooter if the charging port is wet, dirty, debris or looks damaged.
- Connect the plug to E-Scooter's charging port then connect the chargers to an electrical outlet.

## Battery Handling

- Please comply with local laws and regulations when handling and disposal of batteries.
- Don't put rechargeable lithium-ion batteries in household rubbish, normal recycle bins or in kerbside hard waste collection.
- The battery shall be stored in a way to prevent short circuits.
- Special containers and devices (gloves, protective glasses, appropriate protective clothing, and a gas mask) shall be used to treat batteries with liquid leakage.
- Seek advice from your local recycling or waste management facility on proper battery disposal.

## Assemble

Your Electric Scooter comes 90% assembled in the box. You are expected to

- ✓ Attach and tighten the handlebars.
- ✓ Tighten and adjust the angle of your brake levers and display/throttle unit.
- ✓ Check tyre pressure as per the recommended specification located on the tyre wall.
- ✓ Check the operation and functioning of the brakes.
- ✓ Unfold the stem and securely and correctly lock the clamp.
- ✓ Check the brake light and all lights and electronics, including the function of the horn.
- ✓ Check that all nuts and bolts are securely fastened.

While it may seem easy enough, we recommend a professional or E-Scooter technician to perform the correct setup.

Failure to correctly assemble your E-Scooter before riding or using it may put you at risk of serious injury or death.

# Care Maintenance

## Clean and storage of Electric Scooter

Clean all stains on the surface of the E-Scooter, with a soft, clean damp cloth. If there is a tenacious stain, add toothpaste, brush with a toothbrush, and then clean with a moist cloth. If there is a scratch on the plastic part, polish it using abrasive paper or another abrasive substance.

Note: Do not clean the E-Scooter with alcohol, gasoline, kerosene, or any other corrosive chemical solution, as this may harm the appearance or internal structure. It is prohibited to flush using a hydraulic cannon. When cleaning, make sure the E-Scooter is turned off and the power cable is removed, and the charging port lid is closed; otherwise, electric shock or a significant malfunction may occur due to water penetration.

When not in use, keep the E-Scooter in a dry and cool place undercover. Never store your E-Scooter in your bedroom or living areas; it is best to store your E-Scooter separately from your main house like a garden shed. Long-term outdoor storage should be avoided. Outdoor conditions such as direct sunlight, extreme heat or cold will accelerate the aging process of the overall look and tyres, as well as limit the service life of the E-Scooter and its battery pack.

- The battery or E-Scooter must be stored in a dry, well-ventilated area away from living or sleeping areas. Do not store your E-Scooter in the main house/home. Recommend to store in a locked-up garden shed or garage away from your house.
- The battery or E-Scooter must be stored away from any humidity, direct sunlight, heat source, fire source, water, or wet conditions.
- Batteries shall not be modified or linked together to increase battery capacity.
- Do not apply pressure to the battery, which may cause the battery to deform.

## Inflating Tyres

- Please keep E-Scooter tyres inflated to Manufacture's tyre PSI guidelines to avoid punctures and damage to the tyres.
- Note: PSI level can usually be found on E-Scooter tyre wal.

## Adjusting Brakes

- Small adjustments can be made at the barrel adjuster on the brake lever, but all major adjustments should be made at the opposite end of the cable at the brake caliper.
- With the barrel adjuster on the brake lever threaded almost all the way in, adjustments can then be made to the front or rear caliper. If your brakes are too loose, you will need to increase the tension on the brake cable.
- To do this, using a 5mm hex tool, loosen the screw holding down the cable near the caliper. While holding the cable, rotate the brake arm in the direction of the E-Scooter until it can't go any further, making sure to keep tension on the brake cable. Once the arm stops rotating, rotate in the opposite direction a small amount and tighten down the screw.
- If your brakes are too tight, check that nothing is interfering with the brake cable between the handlebars and the caliper. Instead of increasing tension, release it from the brake cable by following the instructions mentioned above.
- Hydraulic brake systems require less maintenance but do need to be bled on a regular basis in order to maintain top performance levels. Bleeding the system involves removing any built-up air in the hoses and topping off the hydraulic fluid and requires a hydraulic brake bleeding kit.
- If you are not comfortable doing this yourself, reach out to your dealer for further directions.

## Transportation

During transportation of your E-Scooter, make sure it's well secured with adequate protection to prevent movement. Straps and padding are advised.

## How to Charge

1. Only use the approved chargers supplied with the E-Scooter. Ensure that the E-Scooter is TURNED OFF then connect the external power charger to the E-Scooter. (Make sure the plugs' grooves are correctly aligned).
2. Connect the charger to an electrical outlet, then turn the power of the electrical outlet on.
3. Do not charge the batteries at temperature below 5°C or above 40°C. The battery may stop the charging process.
4. **RED LIGHT** – Battery is charging.  
**GREEN LIGHT** – Battery is fully charged.

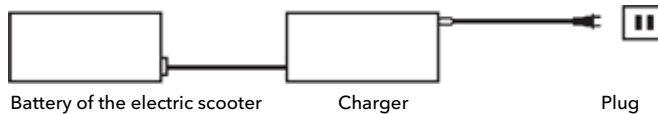

### WARNING:

A popping sound may occur due to the voltage difference when attaching the connector plug to the charging port; this is normal and not a cause for concern. For safety reasons, the dashboard cannot be turned on while the electric scooter is charging, When you want to turn on the electric scooter, please disconnect the charger from the scooter's charging port firstly.

## Pre-Ride Checks

Before each and every ride, always:

1. Check your brakes' function.
2. Check tyres for the correct pressure and any signs of wear or damage. Make sure that the wheels are freely rotating and not obstructed by the brake pads.
3. Check that all screws, nuts, and bolts are tight.
4. Check that the handlebars are tight and firm, and that the brake and throttle levers, as well as the display, are properly adjusted to the optimal viewing angle.
5. Check that the stem folding clamp is correctly locked into position and tight.
6. If you notice something that may not look correct, do not ride or use your E-Scooter.

If you are unsure, bring your E-scooter to our authorized distributor.

# Safe Driving Tips

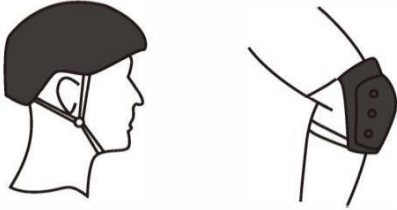

1. To prevent injury, wear safety gear, such as comfortable shoes, a helmet, and knee and elbow padding.
2. The E-Scooter is not waterproof. Never use it in the rain or snow. Do not use it if the roads or paths are wet or icy. Water damage is not covered by the warranty.
3. Do not change the program functions settings of the E-Scooter. Changing from factory settings may result in operational malfunctions and may void your warranty. If you need to change the settings, please ask for help from an expert or authorized dealer.
4. When turning left or right, make sure that there are no obstacles, and then turn slowly, keeping a wide turning radius.
5. An operating age of 18 years old and over is strongly recommended.

## Get to know your E-Scooter before riding

Make your turns slowly and cautiously and give yourself plenty of stopping distance.

To gain control over your E-Scooter, practice your first ride on your E-Scooter in an open space with no obstacles.

The E-Scooter requires a short adjustment break-in period to allow all moving parts to adjust to their correct position.

## RIDING TECHNIQUE

1. Before riding, place your foot as close as possible to the front section of the E-Scooter, and your other foot on the ground. Make sure that your driving route is clear.
2. To start riding, kick start the E-Scooter with your foot for a few meters before activating the throttle.
3. As you accelerate, lean forward.
4. As you brake, tilt your weight backward.
5. Avoid putting body weight on the handlebars whilst accelerating and decelerating.
6. Keep one foot behind the other; (it's more comfortable to place one foot forward and the other one turned backwards at 70-90°, like on a skate/surfboard. It will help you gain more stability.)
7. Braking - Tilt your weight backwards so that the brake action will come through the feet and not through the handlebar and steering system. It is best to learn how to adjust the center of gravity while stopping; otherwise, there is a dual concern: Forward tipping, as well as wear and breaking of the handlebar and steering system.

## Serial numbers

Each Langfeite E-Scooter comes with a unique serial number. These numbers provide information on the authenticity of the E-Scooters and production dates.

To find your serial number:

1. The number is on the backside of the board, for example as below:

*Serial number:* **LFTH1202510160000001**

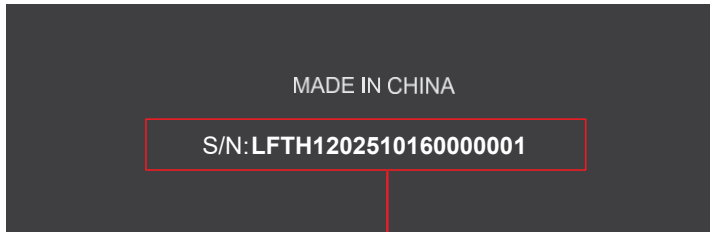

Serial number

## Check the items

---



- **Langfeite H1 Electric Scooter**

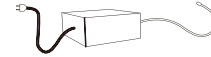

- **Charger**

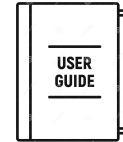

- **User manual**



- **Allen Keys**

## How to assemble the handlebar



1. Place the handle bar in the stem's headset in a correct angle. Use a 4mm Allen key to tighten the bolt.



2. Check the display screws are tightened

### **WARNING:**

Do not hold the handlebar only when lifting the product from the box. Please be careful that the fixing slide of the folding part may be damaged, and a safety accident such as a part of the body may be caught. Therefore, when lifting the product, it is necessary to raise the handle bar first, and then slowly lift the body (footrest) of the product with both hands and do not damage the folding part.

**WARNING: SERIOUS INJURY OR DEATH IF THE LOCKING MECHANISM IS NOT CORRECTLY ENGAGED CAUSING THE STEM TO COLLAPSE DURING USE/RIDE.**

## How to unfold the scooter



1. Raise the handlepost(Steering tube)

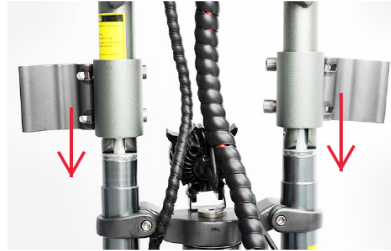

2. Release the locking clamp, and then lower the both locking slide downward.



3. The locking slide should move to the correct position downwards.



4. Tighten the finishing screw properly to lock the clamp ,so that the locking slide is firmly fixed in any direction, and check looseness during use.

**WARNING: SERIOUS INJURY OR DEATH IF THE LOCKING MECHANISM IS NOT CORRECTLY ENGAGED CAUSING THE STEM TO COLLAPSE DURING USE/RIDE.**

CORRECT



INCORRECT

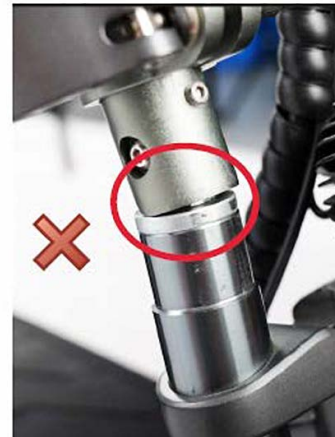

By release and tighten the nut, we can adjust the tightness of the clamp.



## How to Fold



1. Release the locking clamp



2. Move the both locking slide upwards.



3. Fold the handlepost (Steering tube) downwards



**WARNING: SERIOUS INJURY OR DEATH IF THE LOCKING MECHANISM IS NOT CORRECTLY ENGAGED CAUSING THE STEM TO COLLAPSE DURING USE/RIDE.**

## Key features

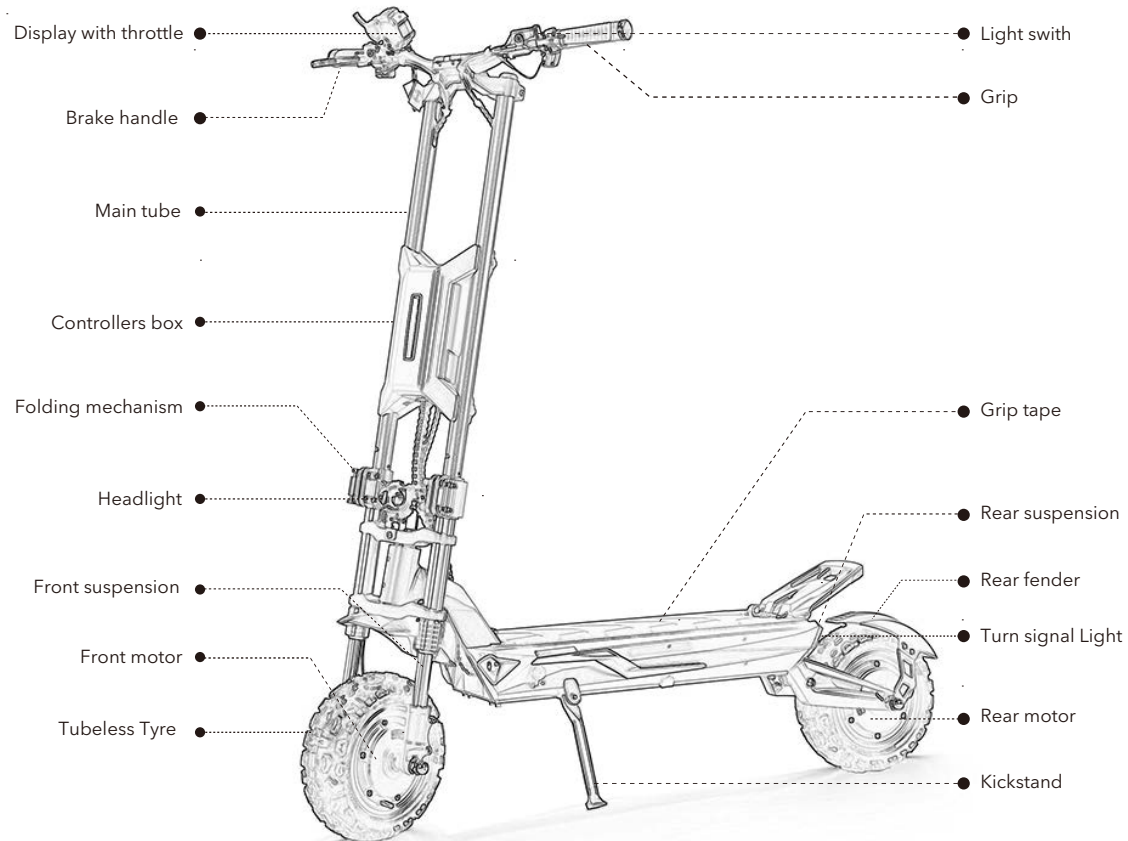

## Key features



## Dashboard Instruction



[1] Gear. Shows the selected gear.

[2] Speedometer: Shows the speed at which you are travelling.

[3] Time: Time since powering on the scooter.

[4] Battery Indicator: Charge your scooter frequently, do not let it run out battery. As a rough guideline, charge at or below 2 bars.

[5] Voltage Value: Shows the current voltage value at which you are travelling.

[6] Accelerator: Pull to accelerate. The stronger you pull, the faster it accelerates. (The accelerator only works if the scooter is already in motion.)

[7] Power Button: To turn the scooter On/Off press button [7] for 5 seconds. Press to select various display options by press the power button [7].

MODE	COMMENT
TIME	Time since powering on the scooter.
TRIP	Distance travelled since powering on the scooter.
ODO	Total distance travelled.
VOL	Current battery voltage.

[8] Mode Button: Press to select various display options:

MODE	COMMENT
Gear 1	Reduce torque and top speed to maximize range.
Gear 2	Standard mode.
Gear 3	No restriction of power.

[9] NFC card: Please use NFC card [9] to approach the sensing area [10]. (Noted: Each E-Scooter is equipped with 2 NFC cards.)

[10] NFC card area: Please use NFC card [9] to approach the sensing area.

## How to Power On/Off H1 Electric Scooter

Power On/Off (2 Methods available)	Optional 1	Use NFC card [9] to approach the sensing area [10] .
	Optional 2	<ul style="list-style-type: none"><li>• To turn the scooter On or Off press button [7] for 5 seconds.</li><li>• Enter a 4-digit password. The factory default password is <b><u>8888</u></b>.</li></ul>
Speed Control	While stationary, and with the power on, press the Mode button [8] to cycle through the three different speed levels 1 to 3. Use the throttle [6] to control the speed within each speed level.	
<b>NOTE:</b> The scooter turns off automatically if it is not used for 5 minute.		

## Detailed P-settings mode.

To access P-settings to make various advanced changes, press Power button [7] and Mode button [8] for 3 seconds.





1. Cycle through the P-settings using the Power button [7] **or** Mode button [8].
2. In order to change a P-setting, press Mode button [8] for 3 seconds.
3. To return to operating mode, wait a few seconds.

item	Details	LANGFEITE H1 Display P-SETTINGS
P00	Wheel diameter	Default 11.0 (Cannot change,11.0=11 inch wheel size)
P01	System voltage	Default 60.0 Do not change.
P02	Pole Pairs of Motor	Default is 15. Do not change.
P03	Speed signal selection	Default is 1. Do not change.
P04	Distance / speed unit	0=km, 1=miles Default: Km/h
P05	Non-Kick start / Kick start	Start setting. 1=Kick start (Kick-and-Go), accelerator won't work if scooter not in motion; 0= immediate start (CAUTION while using this)
P06	Cruise optional	0=cruise control OFF, 1=cruise control ON.
P07	Initial acceleration.	Initial acceleration. 0=strong power, 1=least power.
P08	Speed limit adjustment in percentage	Speed limit as % of top speed, i.e. 100=no speed limit.
P09	EABS strength	Range: 0~2 0=No EABS; 1= the weakest; 2=the strongest;
P10	Display password	Show the display power-on password
P11	Factory setting	Do not change.

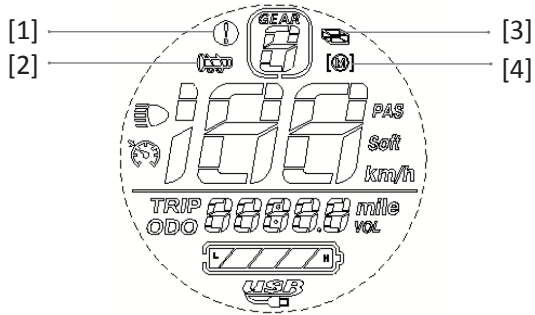
# Dashboard Warning Icons

Fault indicator: When the scooter encounters a malfunction, the fault warning icon will appear on the display.



Warning Icons	Description
	Controller Fault
	Motor Hall Fault
	Brake is working
	Throttle fault

## • New password setting

1. After turning on, enter P-settings by press Power button [7] and Mode button [8] for 3 seconds.
2. Cycle through the P-settings using the Power button [7] or Mode button [8].
3. We can see the 4-digit current password on the P10 settings page.
4. Procedure for entering a new password:
  - Press Mode button [8] for 5 seconds. The flashing password value indicates that the password can be changed.
  - Short press the Mode button [8] to select the desired value, and short press the Power button [7] to confirm and enter the next value setting.
  - After setting a new password with a 4-digit value, Press the Mode button [8] for 3 seconds to confirm the password, and the password value will stop flashing.
  - To return to operating mode, wait a few seconds.



1. Each Langfeite H1 scooter is equipped with 2 NFC cards and 1 black super card.
2. NFC Cards can power On/Off Langfeite H1 electric scooters.
3. If an NFC card is lost, follow these steps to register a new card:
  - Obtain the new NFC card. Use the Black Super Card to input the new NFC card data into the display system.
  - Verify that the new NFC card is recognized by the system.

**⚠ Attention:** Please keep the black **super card** properly and securely to avoid loss. If the super card is lost, the display will no longer be able to re-enter new NFC card data.

## New NFC Card Data Entry Instructions



Step 1: Power on the Langfeite H1 electric scooter.

Step 2: Use the **black super card** to approach the NFC card sensing area, and the NFC display screen will show " **Lu** ". (At this point, a green dot flashes.) 

Step 3: Use a **new NFC card** to approach the NFC card sensing area, and the NFC display screen will show " **Lu.** ". (At this point, two green dots flashing indicate that the new NFC card data has been successfully entered.) 

Step 4: After successfully entering data, restart the Langfeite H1 scooter and the new NFC card can be used normally. If need to add multiple NFC cards, please refer to the above steps.

# Technical specifications

## Langfeite H1

---

### FRAME

Aluminum alloy

### SWING ARM, FRONT SUSPENSION HOLDER, FOLDING LOCK

One piece aluminum forging

### BATTERY OPTIONS

72V 35AH Samsung

Battery energy in Kwh : 2.52

### NET WEIGHT KG

53

### MAX SPEED KM/H

25KM/h after limited

### RANGE WITH AVERAGE SPEED AROUND 25KM/H

110KM

### MOTORS

2000Wx2

### CONTROLLERS

45A x2, sine wave

### DASHBOARD

Centre big LCD display

### BRAKES

Front and Rear full hydraulic brakes with 140mm rotors

### SUSPENSION

Front: Hydraulic Fork Suspensions

Rear: Hydraulic Shock Absorber

### CABLE SYSTEM AND IP RATING

Quick connections for all electric components, for the cables close to handle bar and under the deck. IP 55 for the whole scooter

### FOLDING SYSTEM

Patent designed clamp folding system

### TIRES

11 inch tubeless

### CHARGER

84.0V 4A charger

### MAIN DIMENSIONS (LENGTH X WIDTH X HEIGHT)

1270mm x 260mm x 1300mm

### PACKAGE SIZE (LENGTH X WIDTH X HEIGHT)

1365mm x 385mm x 685mm

## **WARNING**



**For safety reasons, the dashboard cannot be turned on while the electric scooter is charging.**

**When you want to turn on the electric scooter, please disconnect the charger from the scooter's charging port firstly.**

# AFTER-SALES SERVICE LOGBOOK SECTION

Regular service in accordance with the manufacturer's specifications is critical for the product's safety, dependability, and longevity. Failure to execute scheduled service may render your Electric Scooter hazardous and dangerous to use/ride, placing you at risk of serious injury or death.

## Customer/Owner/Rider Acceptance of Terms of Purchase

<b>Full Name</b>		
<b>Email</b>		
<b>Date Purchased</b>	<b>Invoice</b>	
<b>Location Purchased</b>		
<b>MAKE</b>	<b>Model</b>	
<b>Serial Number</b>		
<b>OTHERS</b>		











**LANGFEITE**